

QUER
BARCELONA

QUER
BARCELONA



THIS IS QUER

QUER
BARCELONA

HISTORIA

30
years



QUER
BARCELONA

WHERE IS PORT DE LA SELVA ?



A fishermans town of 800 population

WHERE IS PORT DE LA SELVA ?



VIDEO FPV

QUER
BARCELONA

GULF OF LION

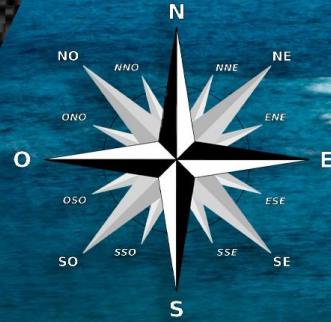

FROM PORT DE LA SELVA TO THE WORLD

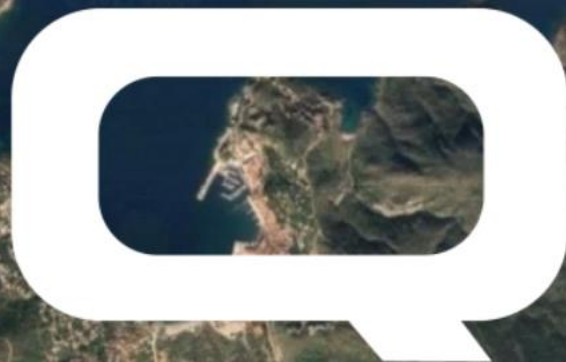

QUER
BARCELONA

INTERNATIONAL FLAGS



BOAT EXPERIENCE (150 BOATS)



ABOUT THE BOAT



TRIPPEL VOLVO PENTA



QUER
BARCELONA

OUR COLLABORATION

QUER

**VOLVO
PENTA**

▶ Ullman

QUER
BARCELONA



QUER

**VOLVO
PENTA**

Ullman

QUER
BARCELONA

FIND THE 7 DIFFERENCES



QUER
BARCELONA

THERE IS ONLY ONE



Quer Eco Fast-System
QEFS®

QUER
BARCELONA

EVOLUTION OF THE BOWS

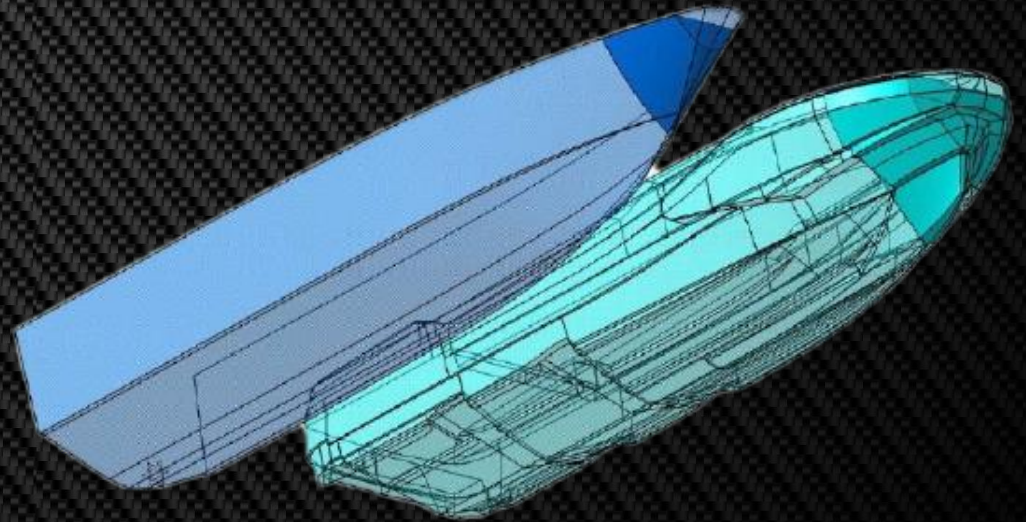
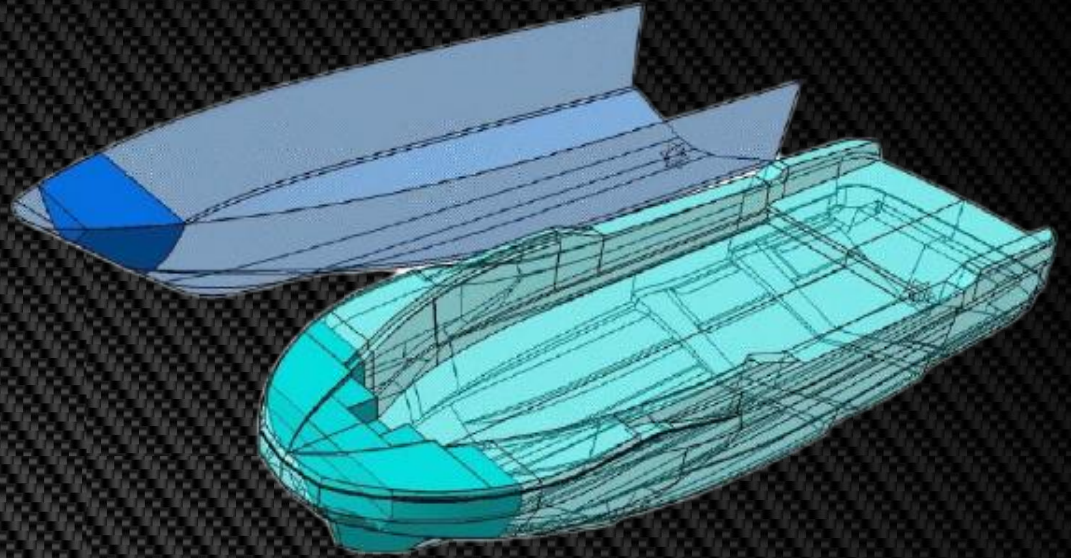
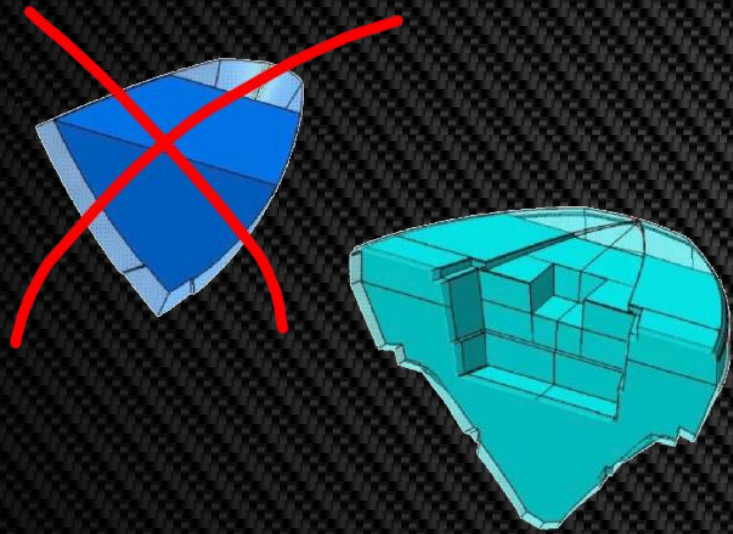



The True Power

QUER
BARCELONA





The True Power

- Our supercavitative bow increases the bouyance
- We lose energy in every splash, so we avoid splashing
- We are always in touch with the water



OUR PATENTED BOW

Nº SOLICITUD: P201331314
 Nº PUBLICACIÓN: ES2531096
 TITULARES: QUER PUIGNAU, Josep Mª

FECHA EXPEDICIÓN: 19/01/2016



TÍTULO DE PATENTE DE INVENCION

Cumplidos los requisitos previstos en la vigente Ley 11/1986, de 20 de marzo, de Patentes, se expide el presente TÍTULO, acreditativo de la concesión de la Patente de Invención. La solicitud ha sido examinada y concedida con realización del Informe sobre el Estado de la Técnica y sin examen previo de los requisitos sustantivos de patentabilidad.

Se otorga al titular un derecho de exclusiva en todo el territorio nacional, bajo las condiciones y con las limitaciones previstas en la Ley de Patentes. La duración de la patente será de veinte años contados a partir de la fecha de presentación de la solicitud (09/09/2013).

La patente se concede sin perjuicio de tercero y sin garantía del Estado en cuanto a la validez y a la utilidad del objeto sobre el que recae.

Para mantener en vigor la patente concedida, deberán abonarse las tasas anuales establecidas, que se pagarán por años adelantados. Asimismo, deberá explotarse el objeto de la invención, bien por su titular o por medio de persona autorizada de acuerdo con el sistema de licencias previsto legalmente, dentro del plazo de cuatro años a partir de la fecha presentación de la solicitud de patente, o de tres años desde la publicación de la concesión en el Boletín Oficial de la Propiedad Industrial, aplicándose el plazo que expire más tarde.

Ana R

Fdo.: Ana María Redondo Mínguez
 Jefa/a de Servicio de Actuaciones Administrativas
 (P.D. del Director del Departamento de Patentes e I.T., resolución 05/09/2007)

ZBM PATENTS & TRADEMARKS

Head Office
 Pl. Catalunya, 1
 ES-08002 Barcelona
 T +34-93 542 61 72
 F +34-93 542 78 70
 zbm@zbm-patents.eu

Madrid
 Cibeles 12
 Pl.2 - Izquierda, Oficina 10
 ES-28020 Madrid
 T +34-91 1893175
 F +34-91 1531160
 zbm@zbm-patents.eu

Paris Clientèle Barcelona
 Begoñe Reñac, 4
 ES-08002 Barcelona
 T +34-93 403 45 29
 F +34-93 403 72 87
 zbm@zbm-patents.eu

Denmark
 Syngedalsvej 3
 DK-2150 Copenhagen Ø
 T +45-792 81023
 F +45-792 81023
 dk@zbm-patents.eu

Barcelona, October 10th, 2018

To whom it may concern:

In my capacity as European Patent Attorney and member of Association of Professional Representatives before the European Patent Office n° 371, I declare:

- That on September 9th, 2014 ZBM Patents & Trademarks filed a PCT application, with application n° PCT/EP2014/069175, on behalf of Josep Maria Quer Puignaau describing and claiming a bow of a boat;
- That the PCT application claims priority from a prior Spanish patent application with application n° P201331314 with a filing date of September 9th, 2013;
- That in July 2016, the application entered the European regional phase and is now pending before the European Patent Office with application n° EP 14 765 909.8;
- That on September 4th, 2018, we received an Official Communication from the European Patent Office indicating that all substantive objections have been overcome, and it is therefore to be expected that the Examining Division will shortly issue a Communication indicating its intention to grant the patent; and
- That France is one of the designated countries in the European patent application and pursuant to Art. 64(1) EPC, the patent once granted will confer on its proprietor, the same rights as would be conferred by a granted French national patent.

Mathieu de Rooij



ZBM PATENTS & TRADEMARKS
 Pl. Catalunya 1 - ES-08002 Barcelona SPAIN
 T +34 93 542 61 72 F +34 93 542 78 70
 www.zbm-patents.eu

mderooij@zbm-patents.eu

European Patent Attorney, ZBM Patents & Trademarks

EUROPEAN & SPANISH PATENT ATTORNEYS
 Spanish Trademark Attorney and Authorized Representative before EUIPO, for EU Trademarks and Designs

www.zbm-patents.eu

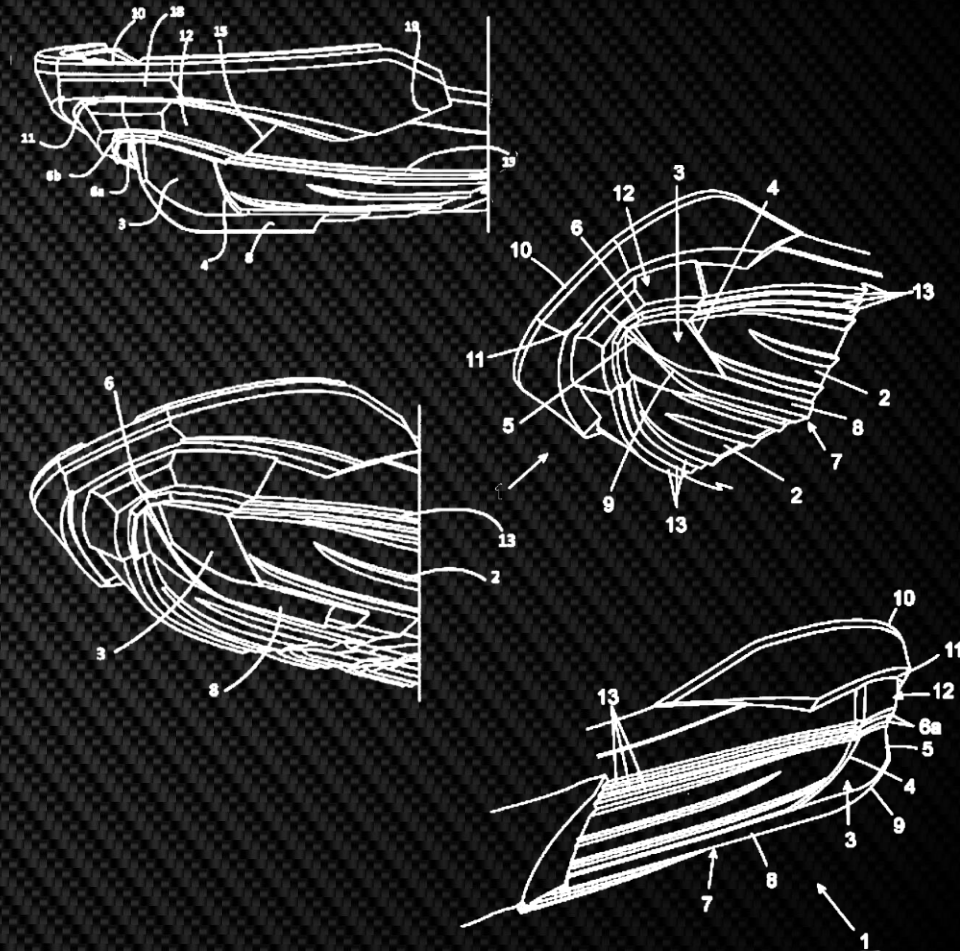

QUER
BARCELONA



QUER
BARCELONA

QUER

BARCELONA

We encourage you to try our new
Trippel Diesel DPI 1320 HP